

INVIKTUS

COFFRE-FORT / SAFE

Mini-guide de l'utilisateur / Quick User Guide

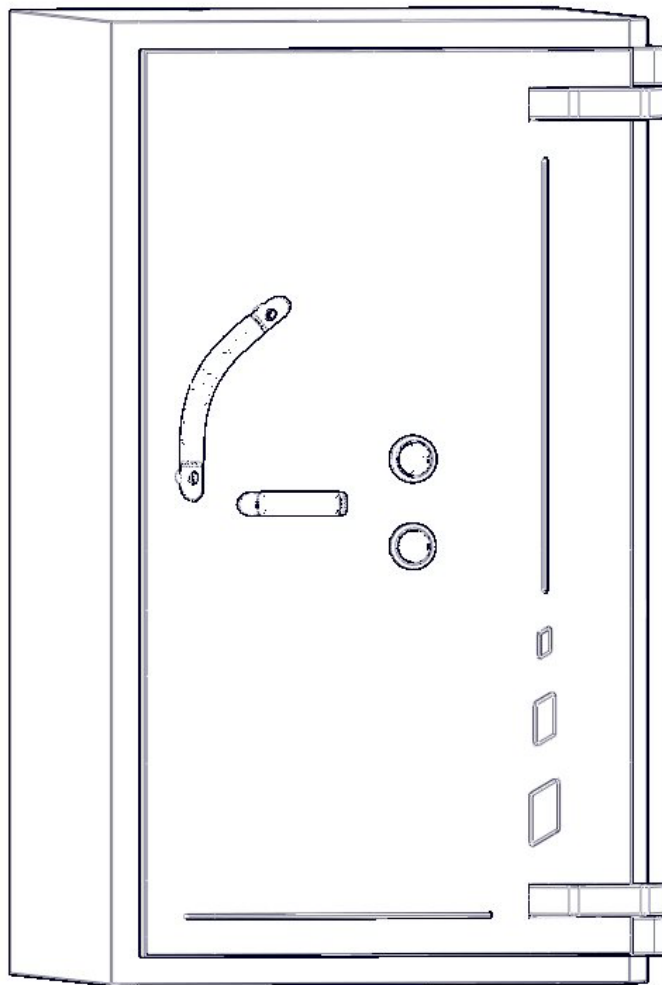

COPYRIGHT

Ce document est la propriété exclusive de Fichet-Bauche, société du groupe Fichet. Toute reproduction en est formellement interdite. Fichet-Bauche se réserve le droit d'y apporter toute modification sans préavis.

Les marques mentionnées dans ce document appartiennent à leurs propriétaires respectifs. Les photos présentées dans ce document sont non contractuelles.

This document is the exclusive property of Fichet-Bauche, a firm of Fichet Group. All reproduction is strictly prohibited. Fichet-Bauche reserves the right to make any changes without notice.

The brands mentioned in this document belong to their owners. The pictures shown in this document aren't contractual.

Copyright © Fichet-Bauche 2022

PROTECTION DE L'ENVIRONNEMENT / ENVIRONMENT PROTECTION



Conformément à la directive 2012/19/UE relative aux Déchets d'Équipements Électriques et Électroniques (DEEE), ce produit, une fois en fin de vie, ne doit pas être mêlé aux ordures ménagères mais doit faire l'objet d'une collecte sélective permettant le recyclage. Cette action contribue à la protection de l'environnement.

In compliance with the directive 2012/19/UE on Waste from Electrical and Electronic Equipment (WEEE), this product, once at the end of his life, should not be mixed with household waste but should be subject to selective collection for recycling. This action contributes to the protection of the environment.



L'emballage carton de ce produit est recyclable.

The cardboard packaging of this product is recyclable.

RoHS

Produit conforme à la Directive 2011/65/UE (RoHS).

Product complies with the Directive 2011/65/UE (RoHS).



GARANTIE / WARRANTY

La durée de garantie applicable au produit est mentionnée dans nos CGV (Conditions Générales de Vente) telles qu'annexées à votre offre tarifaire ou à votre contrat le cas échéant.

The warranty period applicable to the product is mentioned in our General Terms of Sale as attached to your price offer or your contract if applicable.

LIRE CE DOCUMENT / READ THE DOCUMENT



Attention : ce symbole indique un point auquel il faut prêter une attention particulière.
Attention: This symbol indicates an item that requires special attention.



Information : Conseil important d'utilisation et information.
Information: Important advice for use and information.

Fichet-Bauche est une marque de Fichet Group

FICHET GROUP
7 rue Paul Dautier
78140 Vélizy-Villacoublay – France

www.fichetgroup.com

 **Fichet Bauche®**

Table des matières / Table of contents

Fixation du coffre / Safe Fixing	4
INVIKTUS 120	5
MXB / MXB + MXB	6
Monéo / MXB + Monéo	7
Nectra / Nectra + MXB	8
Kelnet / Kelnet + MXB	9
Kelnet	11
Kelnet C ou D / Kelnet C ou D + MXB	13
Kelnet C ou D	15

Fixation du coffre / Safe Fixing

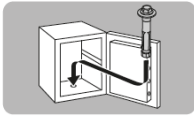

GB Safe Fixing
FR Fixation du coffre

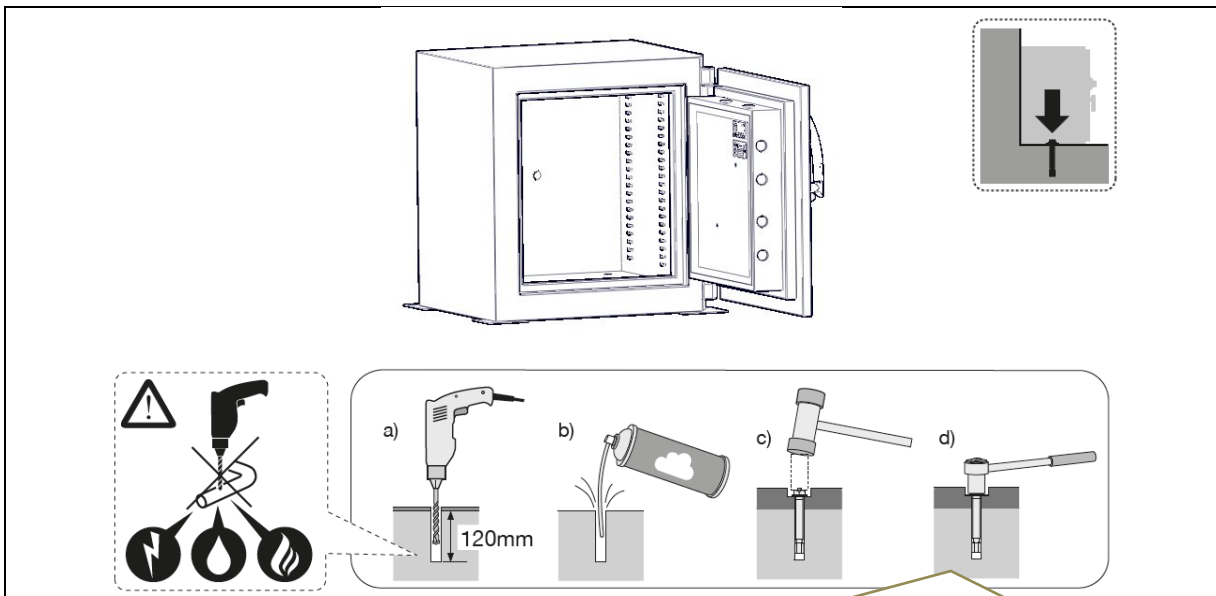
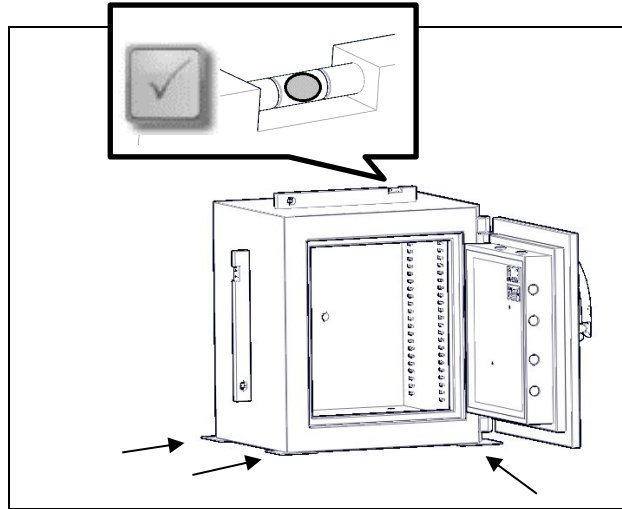
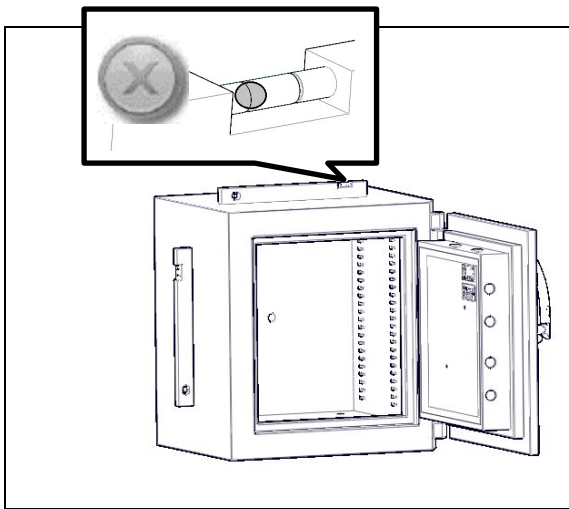
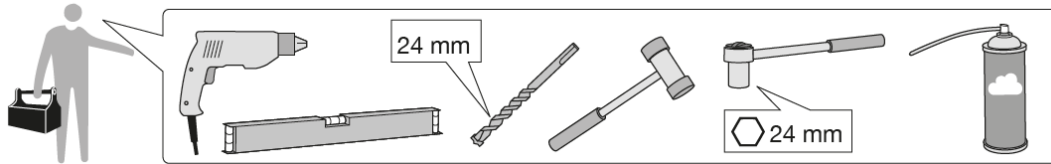

FR Pour une fixation conforme aux normes, la cheville de fixation fournie avec le coffre doit être fixée dans un support béton présentant une compression de 250 MPa en appliquant un couple de serrage de 150 Nm.

GB For a compliant fixing, the expansion bolt supply with the safe must be fixed in a concrete compressive support of 250 MPa and the tightening torque must be of 150Nm.

Inviktus 120

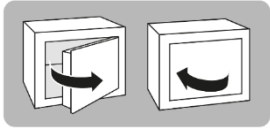

GB To open and close the safe
FR Pour ouvrir et fermer le coffre

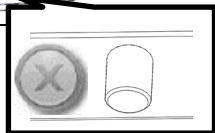
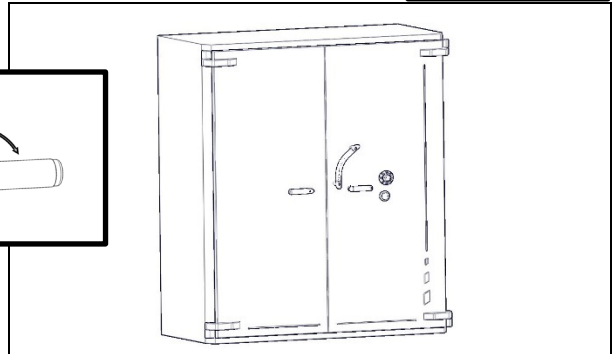
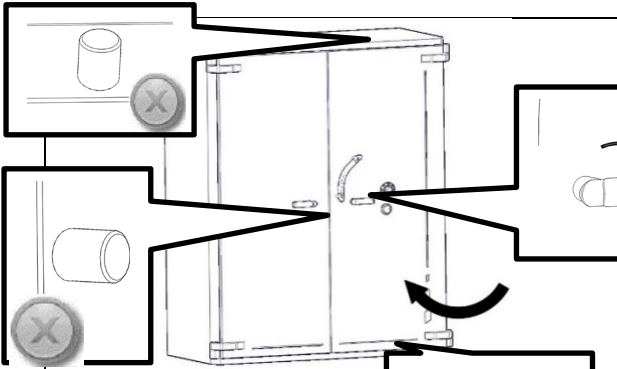
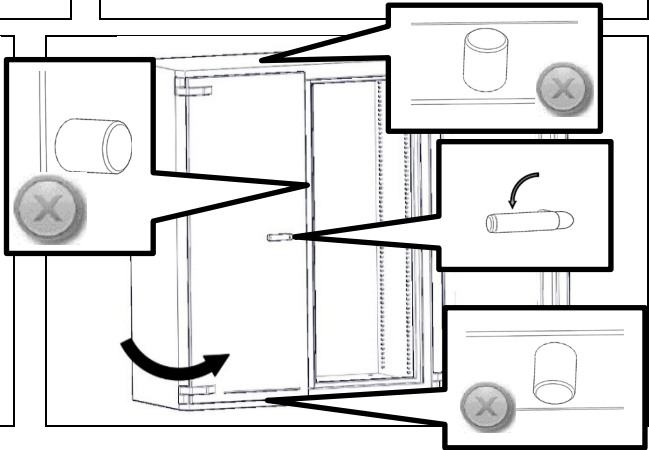
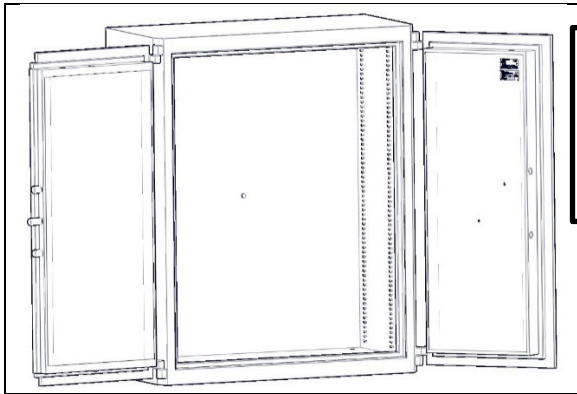
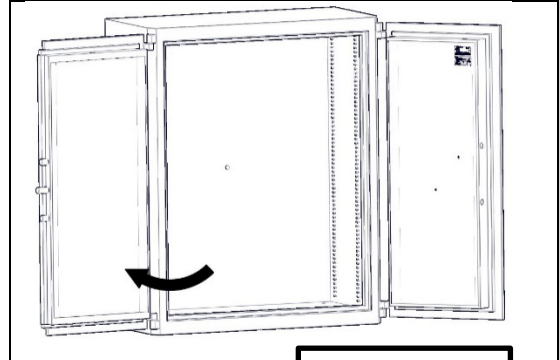
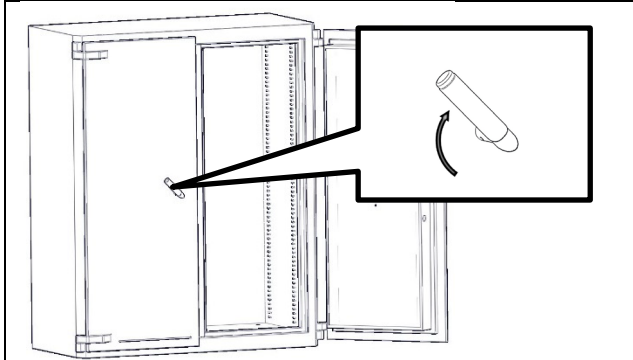
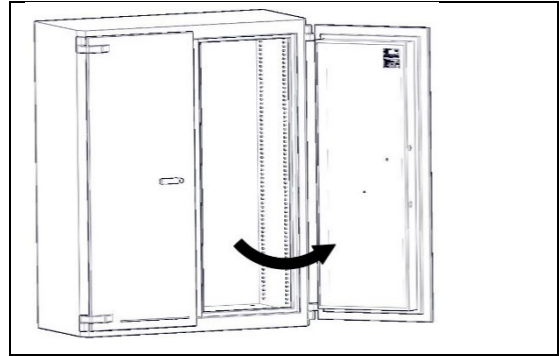
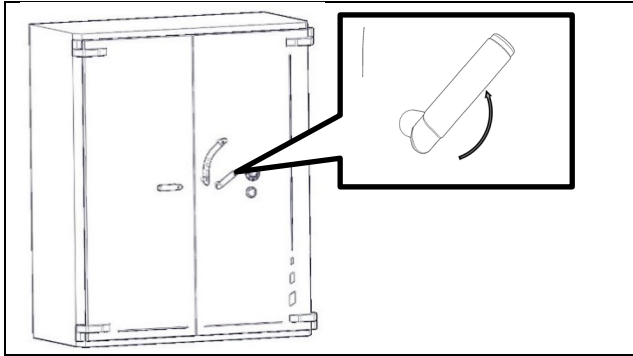

MXB / MXB + MXB

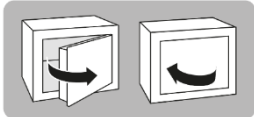
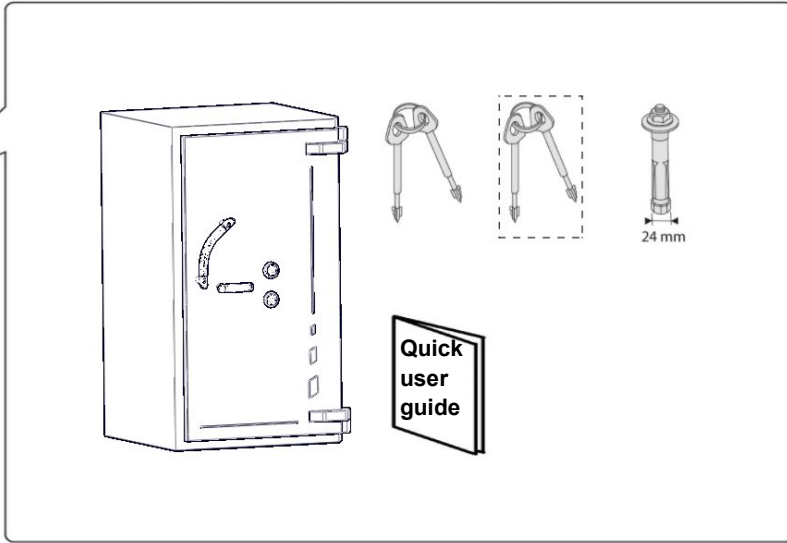

GB
FR

To open and close the safe
Pour ouvrir et fermer le coffre

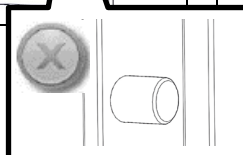
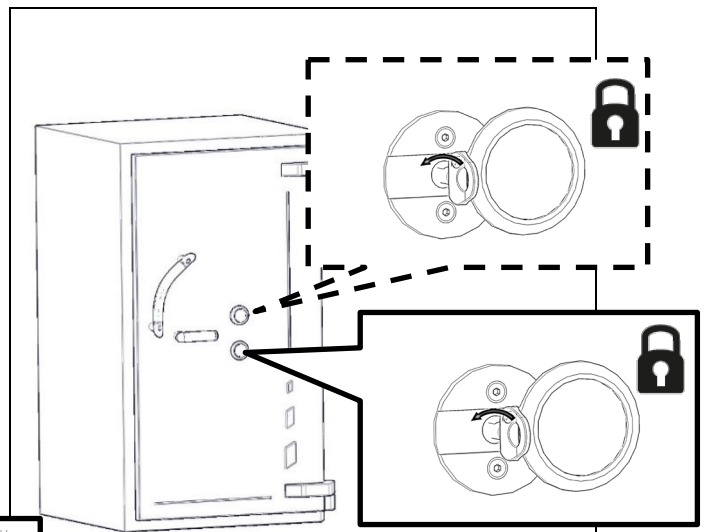
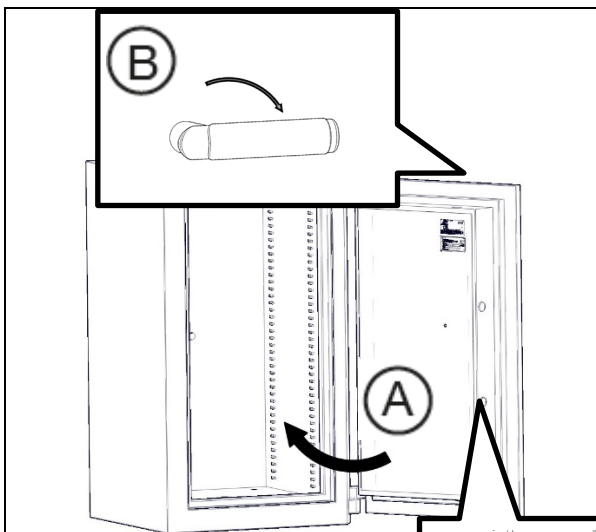
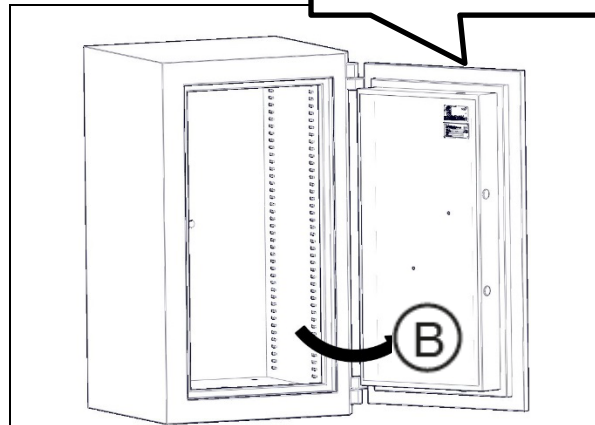
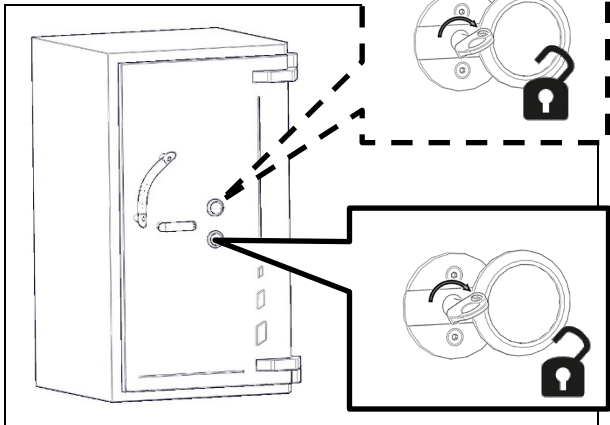
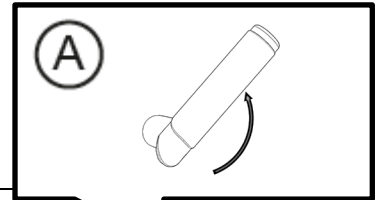

Monéo / MXB + Monéo

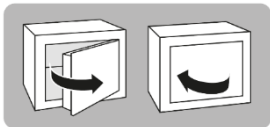
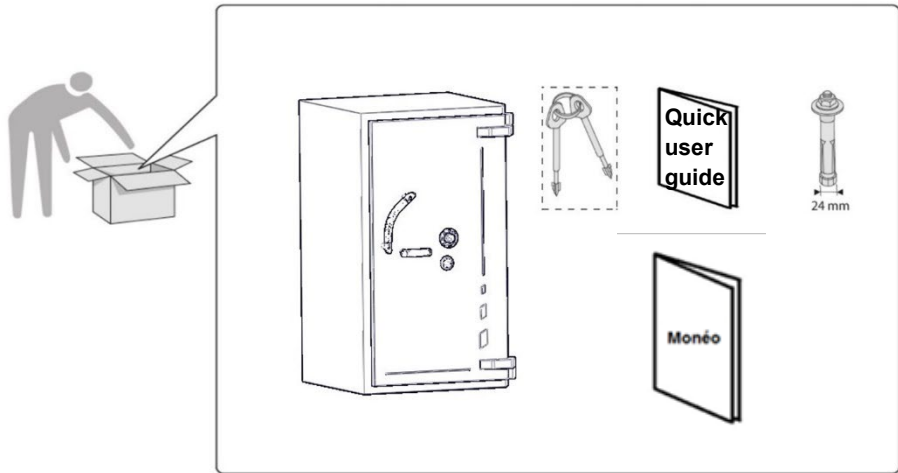

GB To open and close the safe
FR Pour ouvrir et fermer le coffre

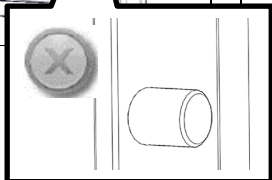
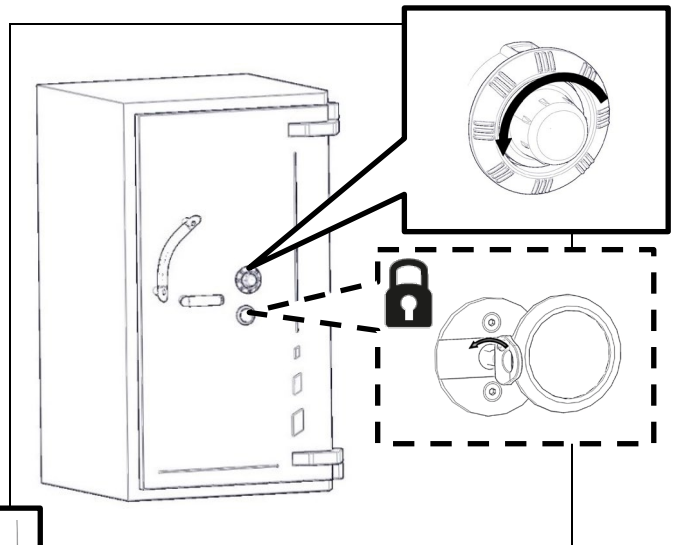
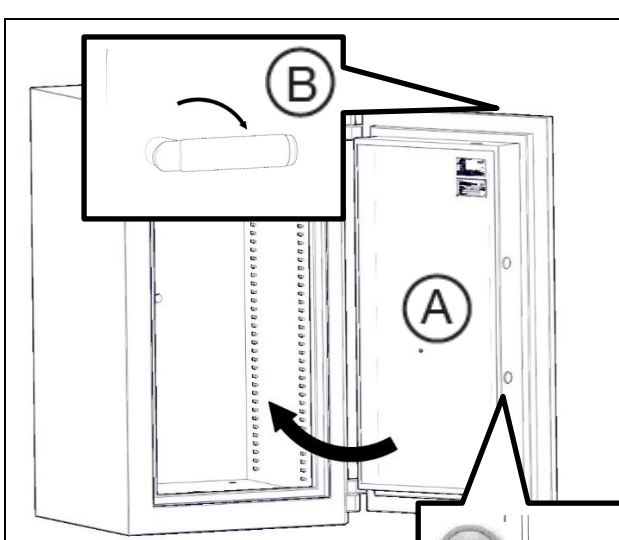
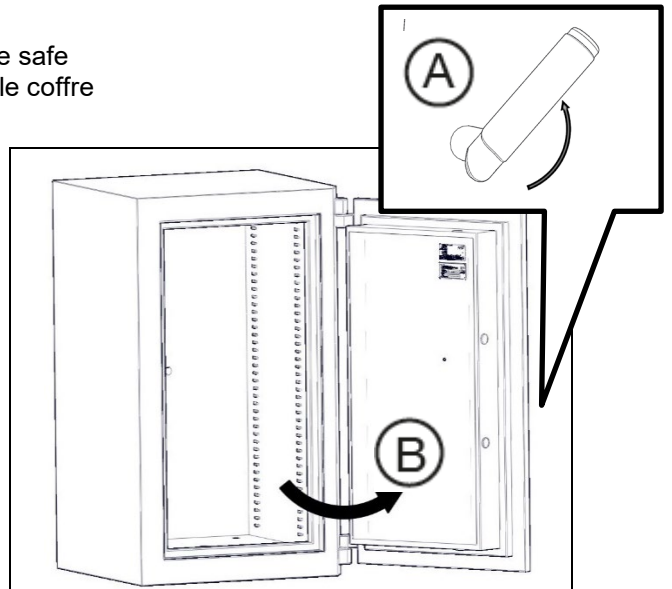
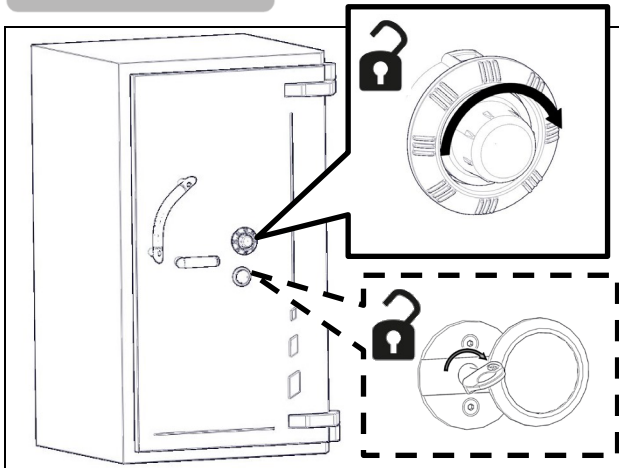

Nectra / Nectra + MXB

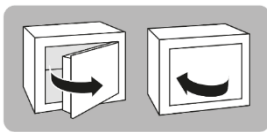
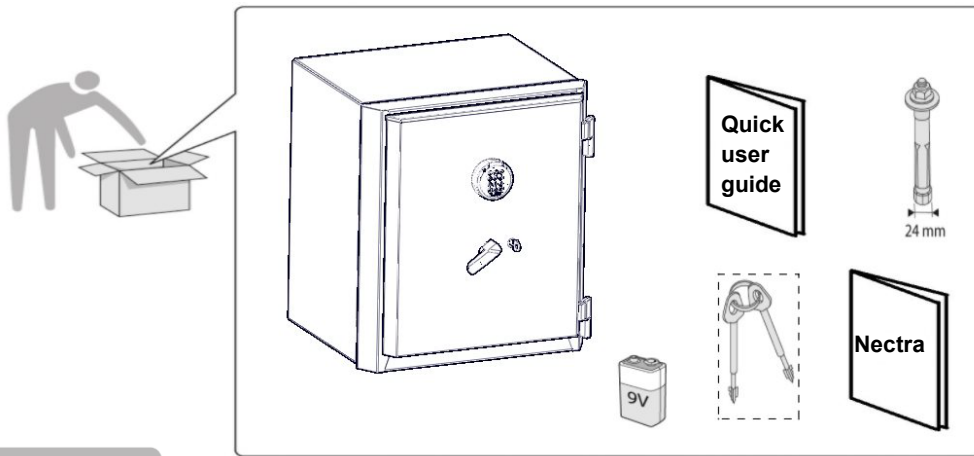

GB To open and close the safe
FR Pour ouvrir et fermer le coffre

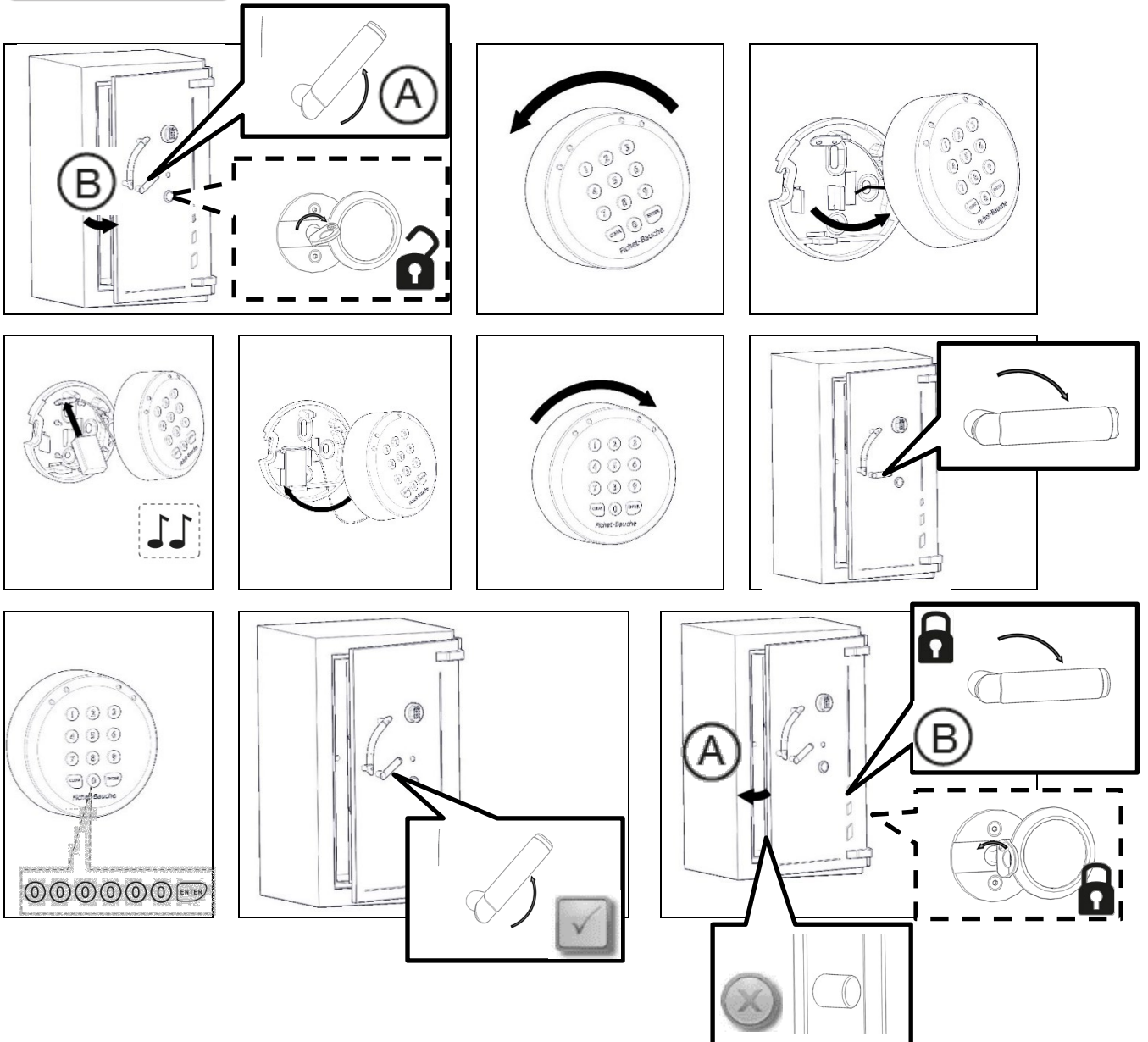

Kelnet / Kelnet + MXB

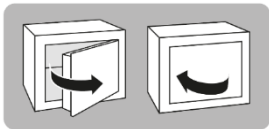
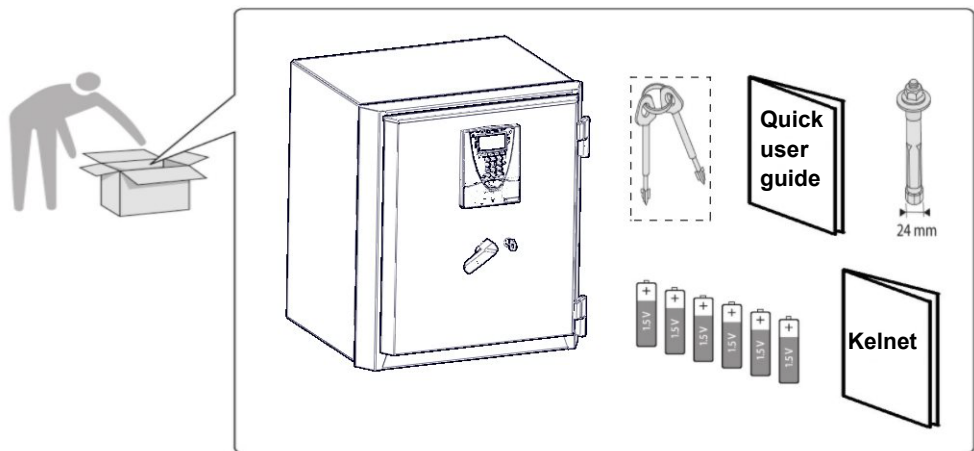

GB To open and close the safe
FR Pour ouvrir et fermer le coffre

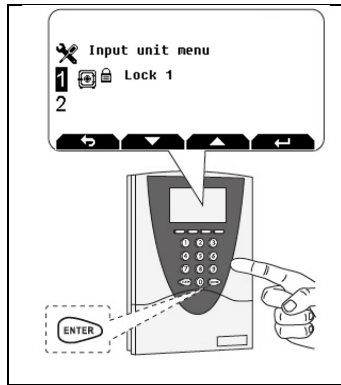
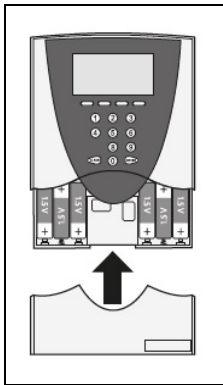
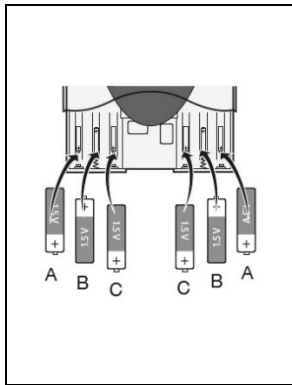
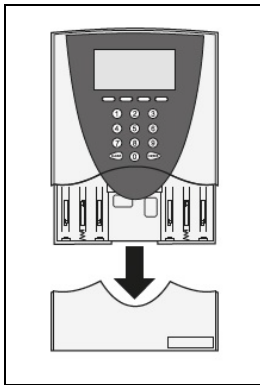
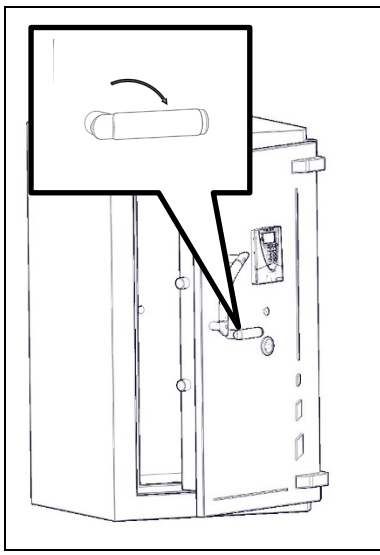
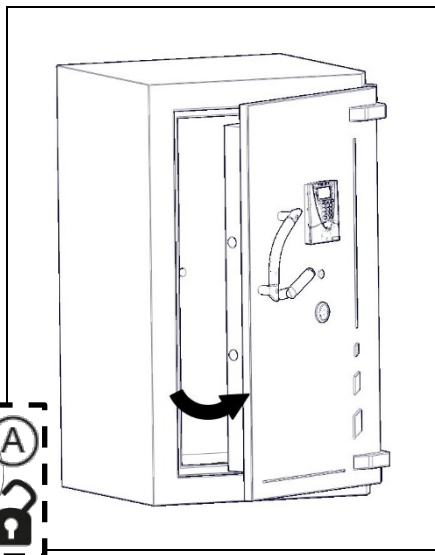
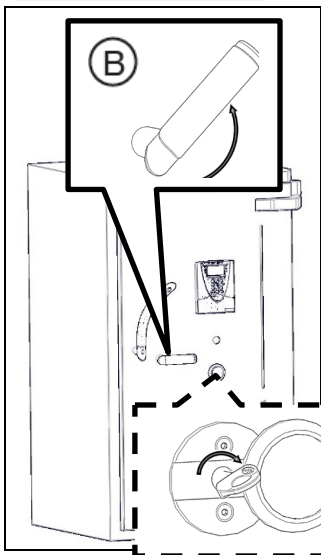

Kelnet / Kelnet + MXB

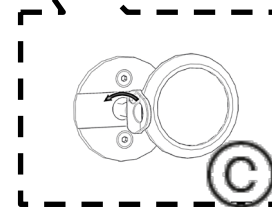
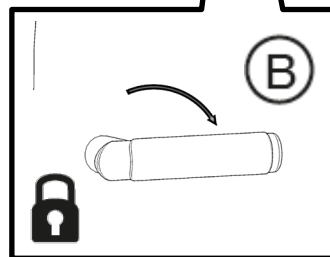
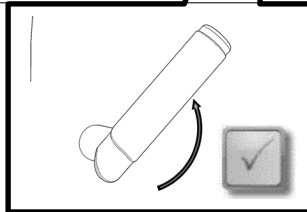
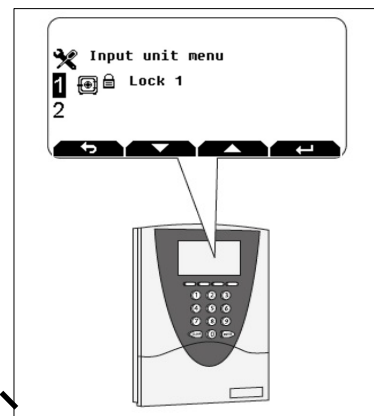
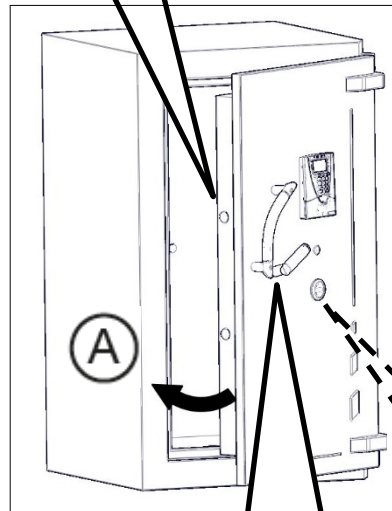
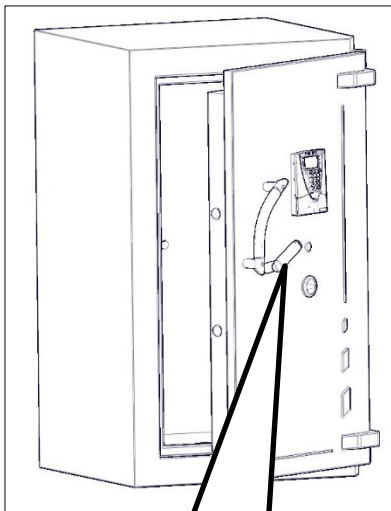
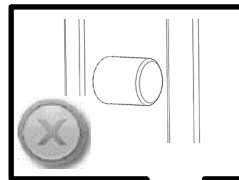
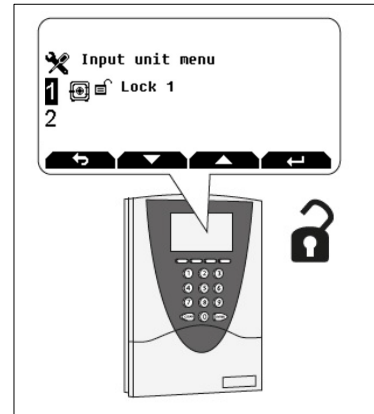
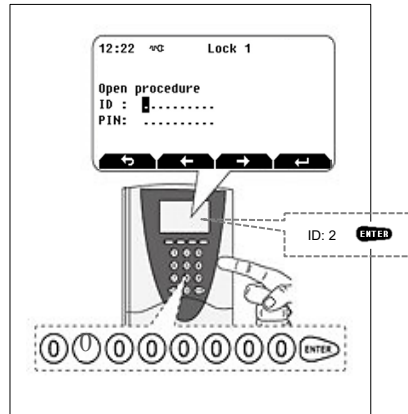
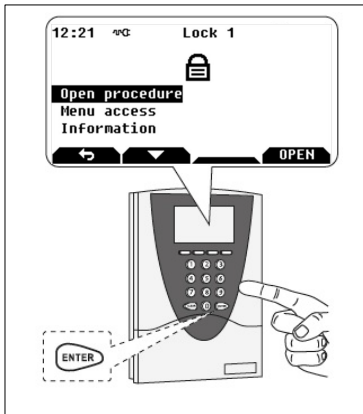

Kelnet

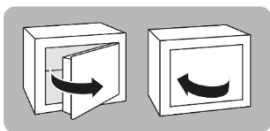
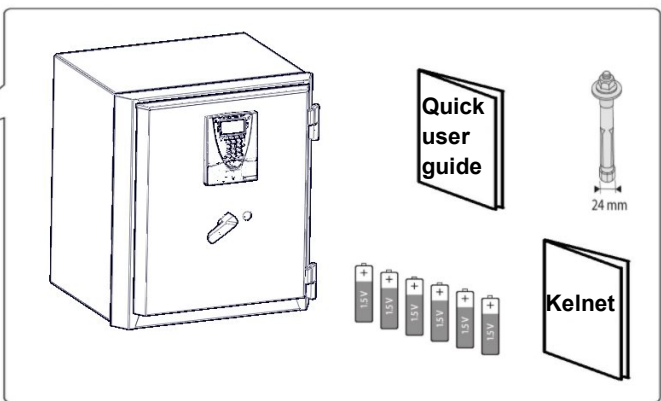

GB To open and close the safe
FR Pour ouvrir et fermer le coffre

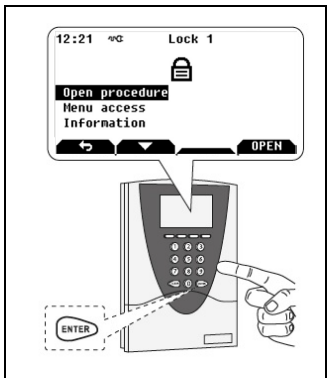
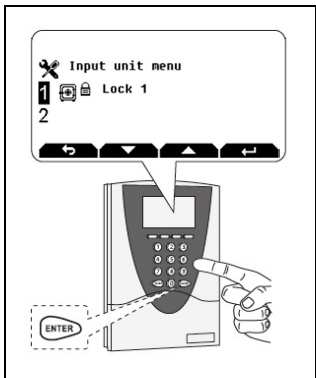
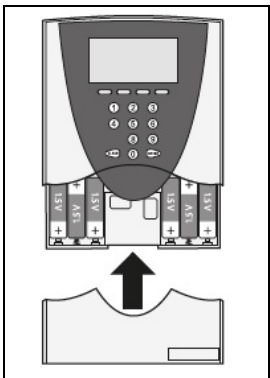
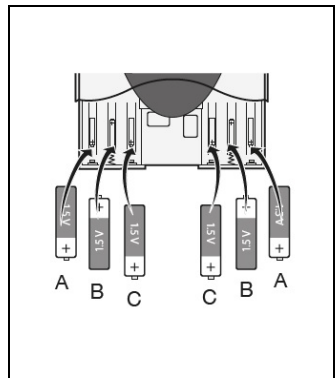
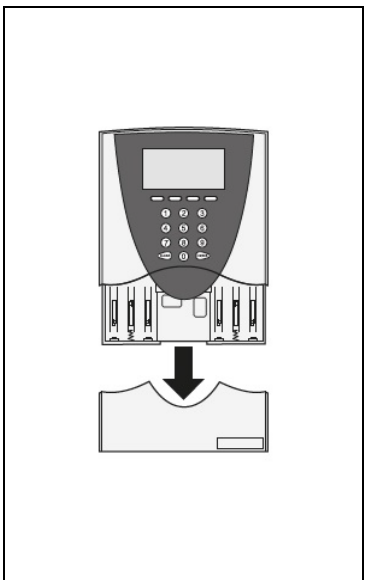
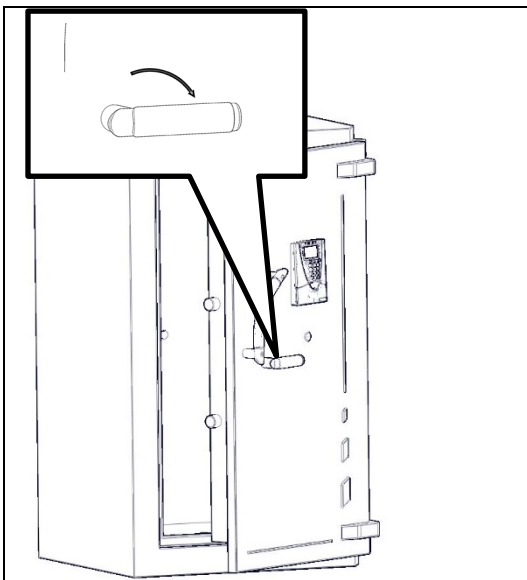
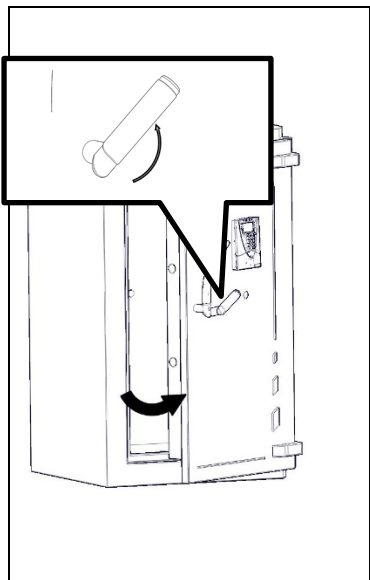

Kelnet

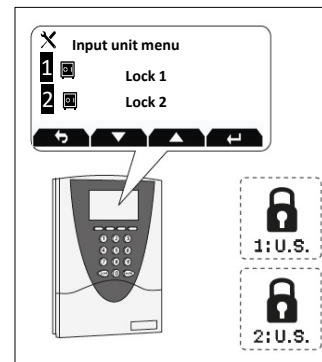
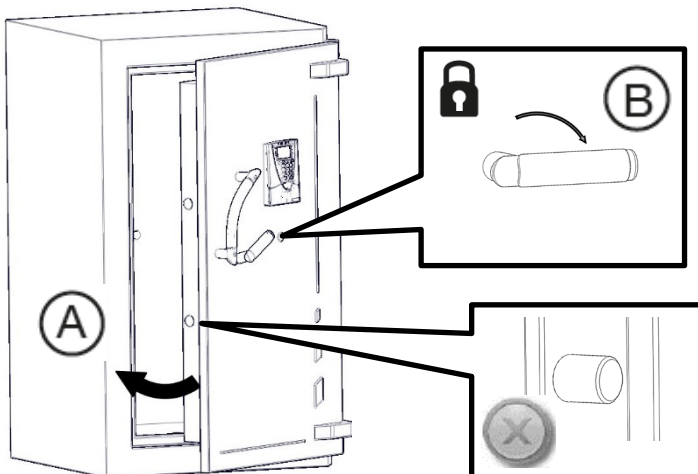
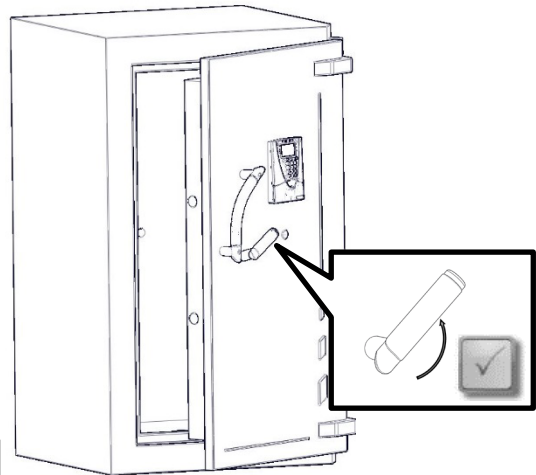
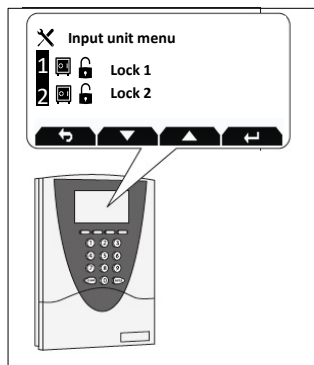
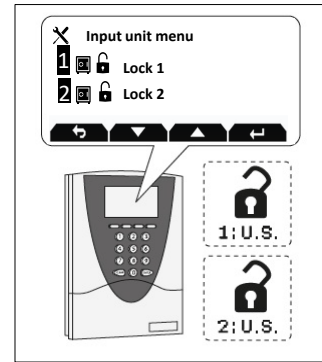
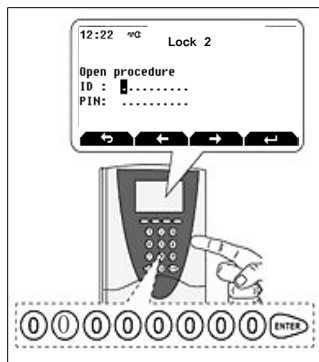
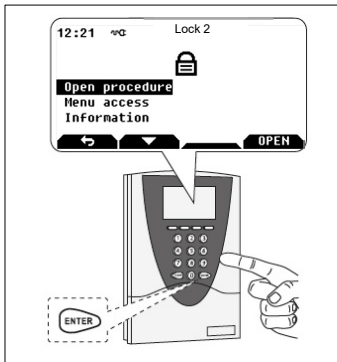
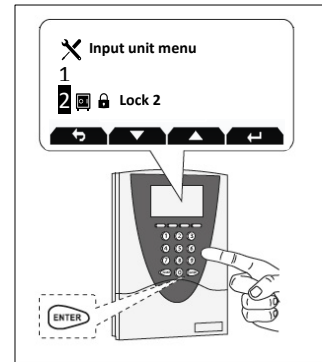
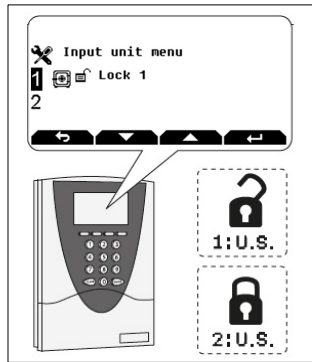
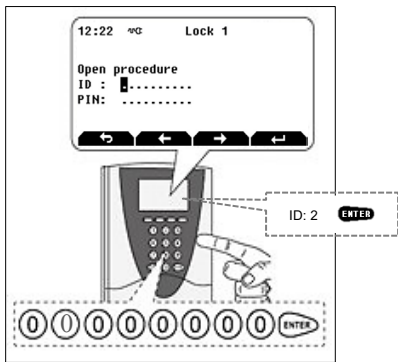

Kelnet C ou D / Kelnet C ou D + MXB

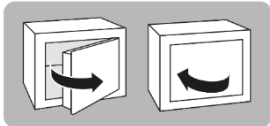
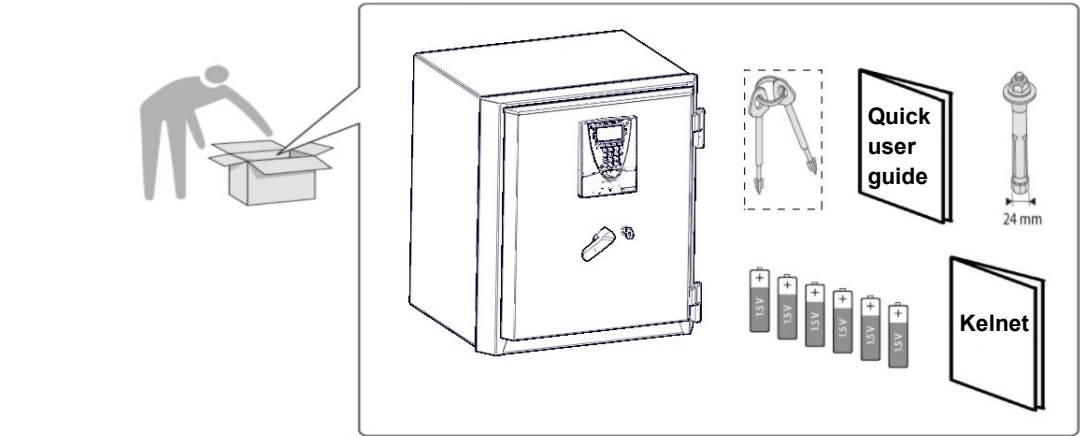

GB To open and close the safe
FR Pour ouvrir et fermer le coffre

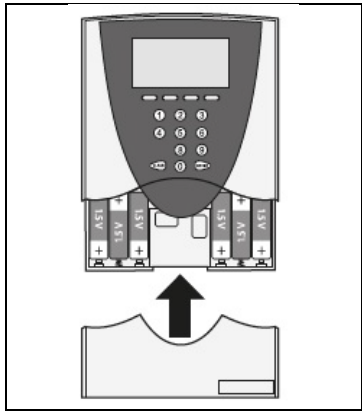
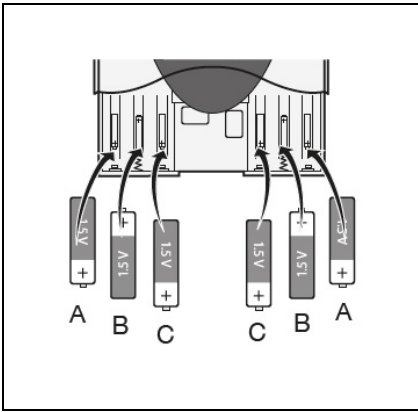
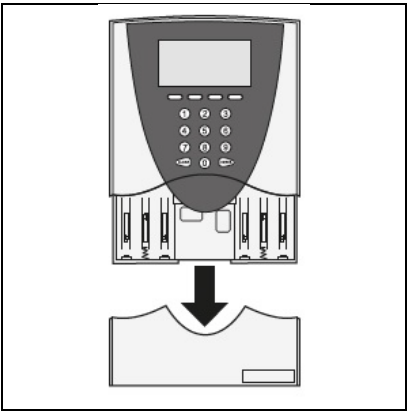
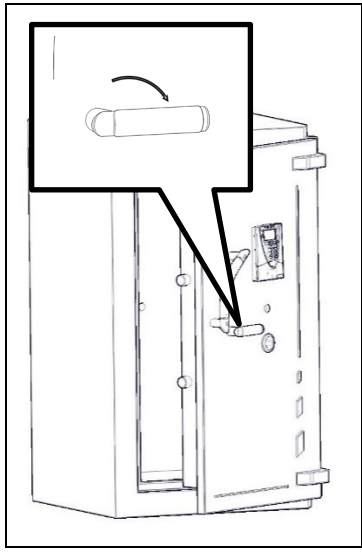
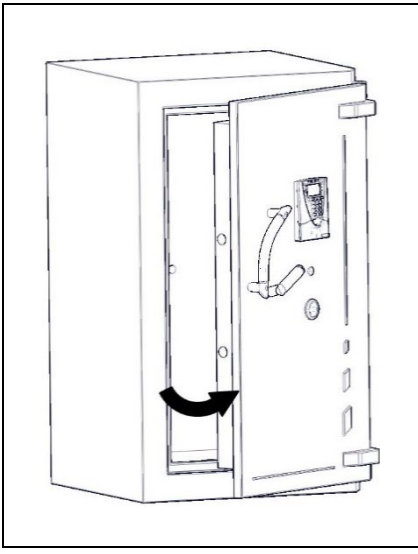
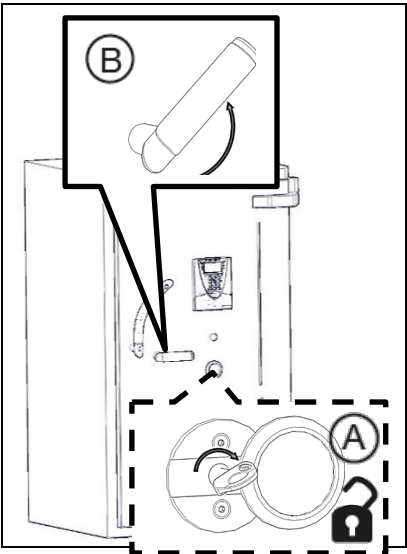

Kelnet C ou D / Kelnet C ou D + MXB

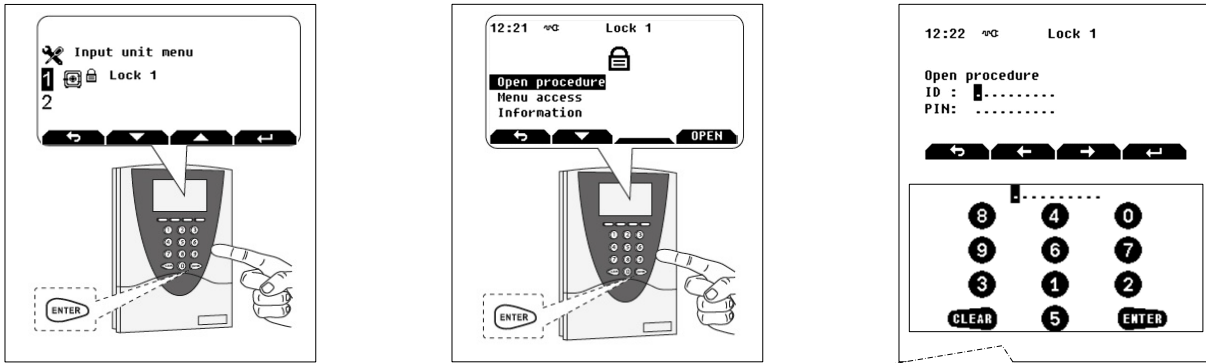

FR Dans le cadre d'une serrure classe C ou D, utilisez le clavier virtuel affiché à l'écran (dans cet exemple, la touche 1 correspond au chiffre 8, la touche 2 correspond au chiffre 4, etc.).

GB With a class C or class D lock, use the virtual keyboard on the screen (in this example, key 1 corresponds to figure 8, key 2 corresponds to figure 4, etc.).

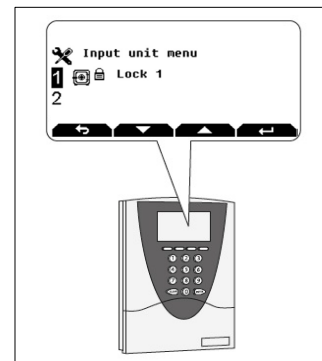
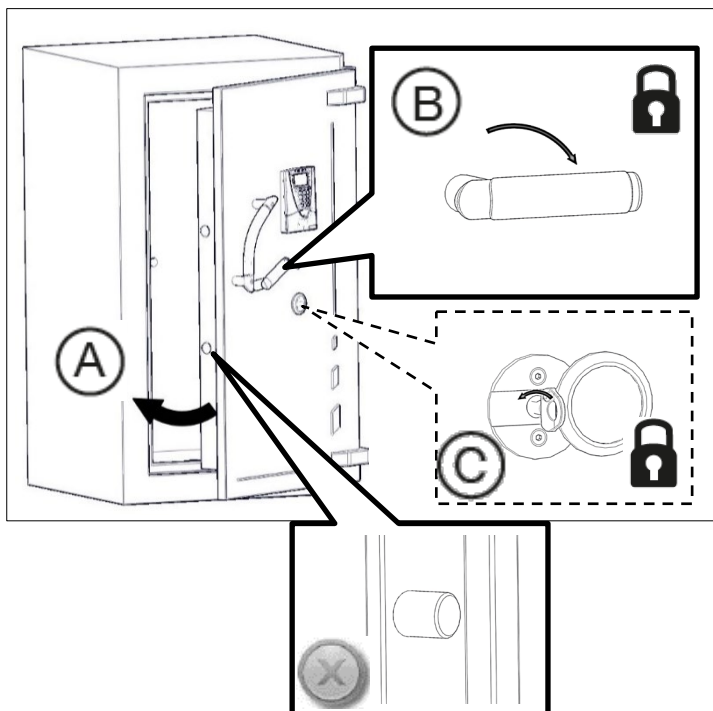
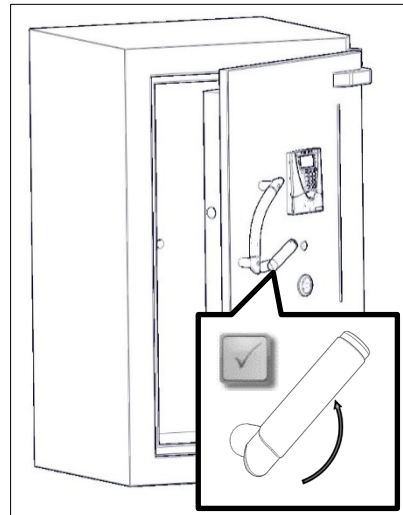
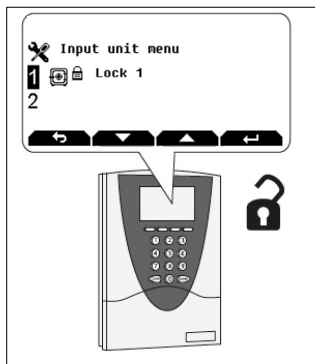

Kelnet C ou D

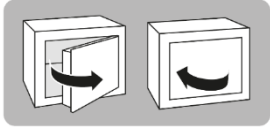

GB To open and close the safe
FR Pour ouvrir et fermer le coffre

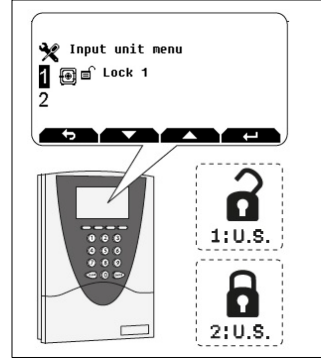
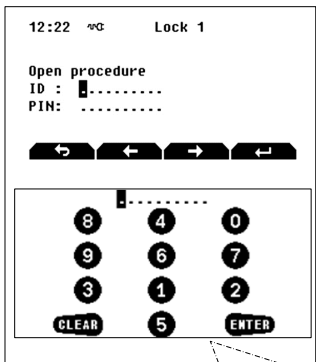
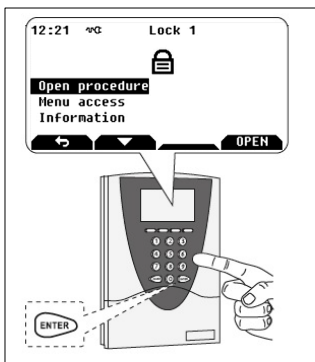
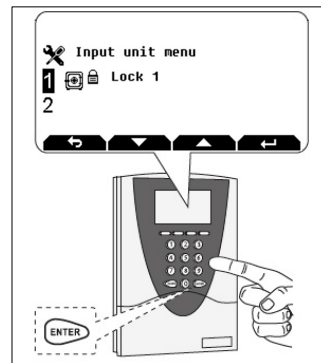
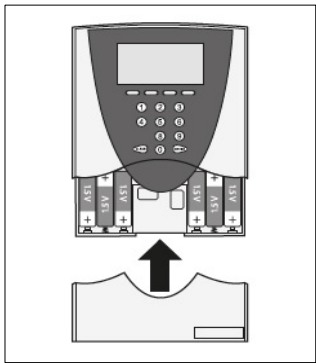
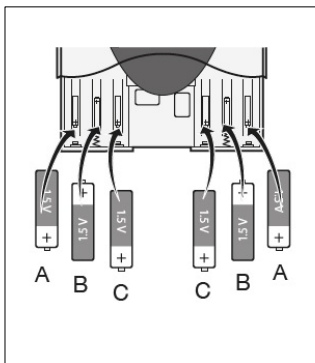
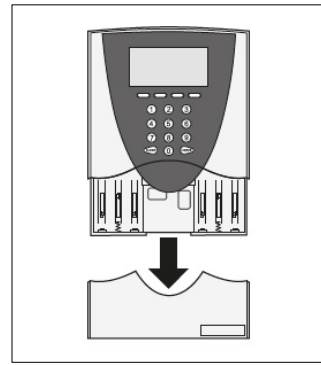
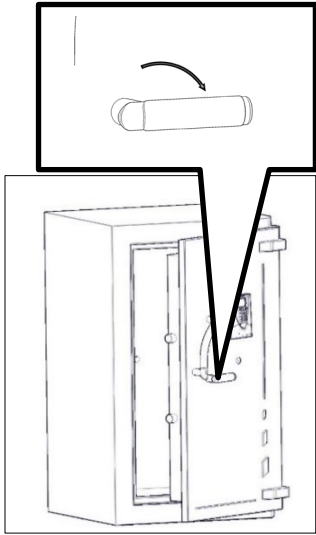
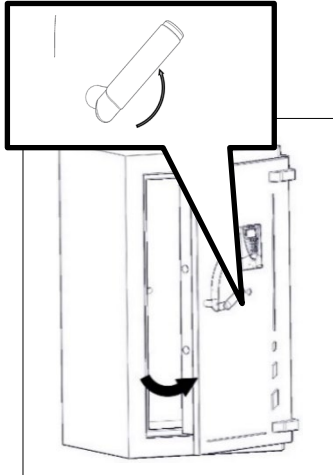

FR Dans le cadre d'une serrure de classe C ou D, utilisez le clavier virtuel affiché à l'écran (dans cet exemple, la touche 1 correspond au chiffre 8, la touche 2 correspond au chiffre 4, etc.).

GB With a class C or a class D lock, use the virtual keyboard on the screen (in this example, key 1 corresponds to figure 8, key 2 corresponds to figure 4, etc.).

Kelnet C ou D

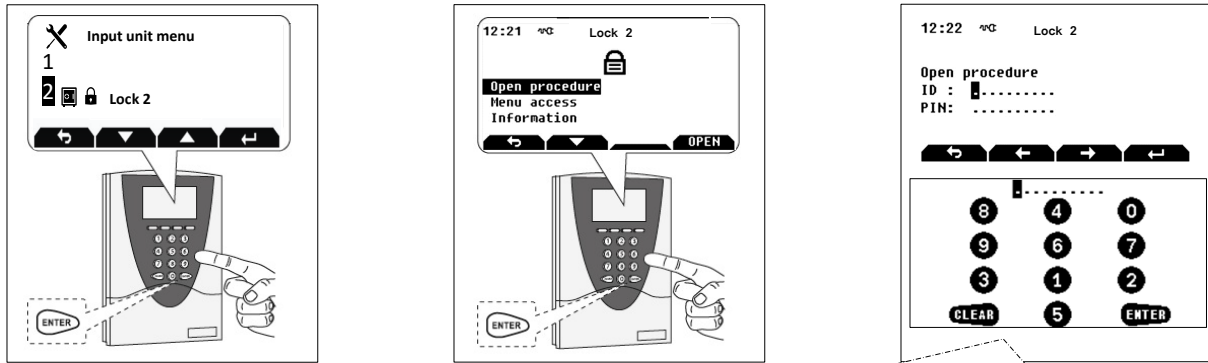

FR Dans le cadre d'une serrure de classe C ou D, utilisez le clavier virtuel affiché à l'écran (dans cet exemple, la touche 1 correspond au chiffre 8, la touche 2 correspond au chiffre 4, etc.).

GB With a class C or a class D lock, use the virtual keyboard on the screen (in this example, key 1 corresponds to figure 8, key 2 corresponds to figure 4, etc.).

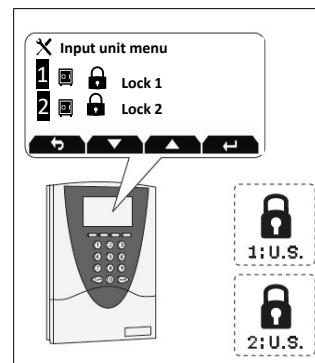
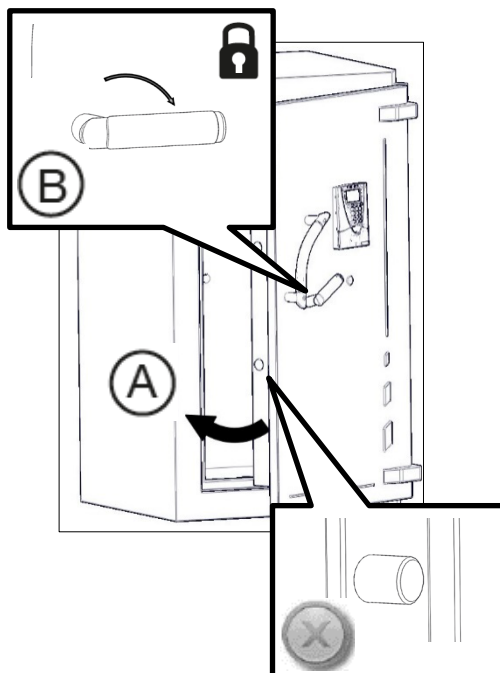
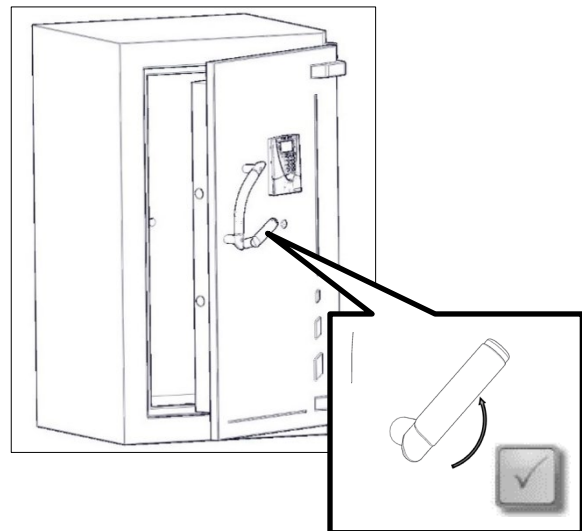
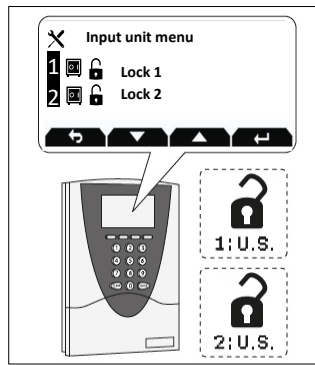

Authorised dealer:
Cachet de votre revendeur :



 **Fichet Bauche®**

FICHET CENTRE RELATION CLIENTS

Tél. : 01 78 42 56 56 | Fax. : 01 78 42 56 57
fichetcrc@fichetgroup.com

Fichet Group

7 rue Paul Dautier - CS 50011
78141 Vélizy-Villacoublay Cedex
France

